



ASSEMBLY INSTRUCTIONS



Item No: Table

Thank you for purchasing this quality product.

PARTS LIST:

No.	Description	Sketch	Quantity
1	A		1PC
2	B		4PCS

HARDWARE LIST:

No.	Description	Sketch	Size	Quantity
1	Bolt 1		M6*60	8PCS
2	Flat Washer 2		Ø6*16	8PCS
3	Hexagon key 3		4mm	1PC

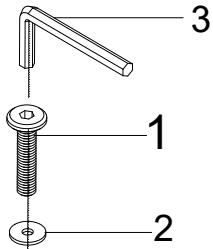

Step 1

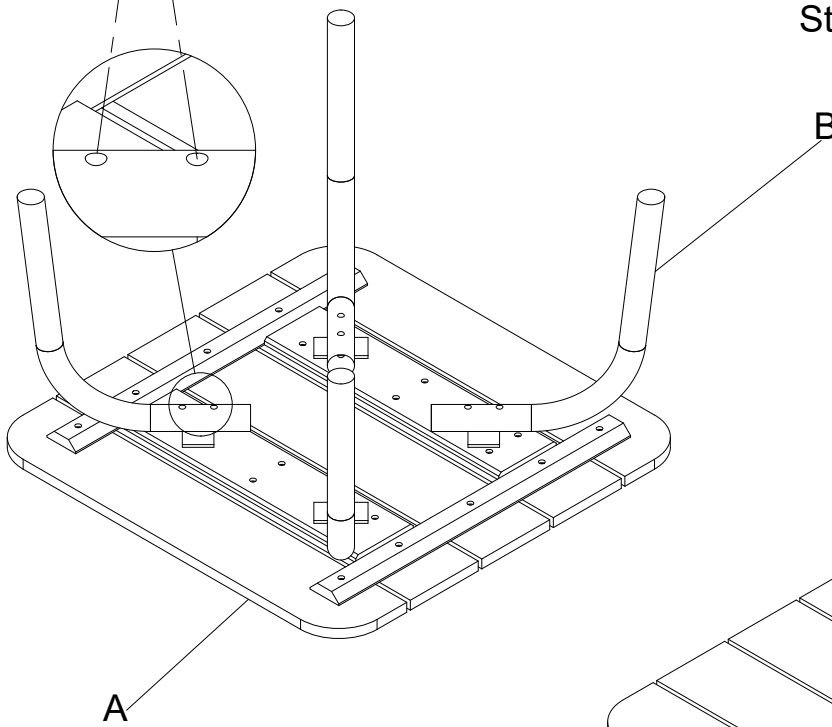

Step 2

